

Product Components

- ① Electric Strike Body & Faceplate ② #12-24 x 1/2" Mounting Screws ③ Plug In Connectors*

*Only 1 Plug In Connector is used with 310-6-30

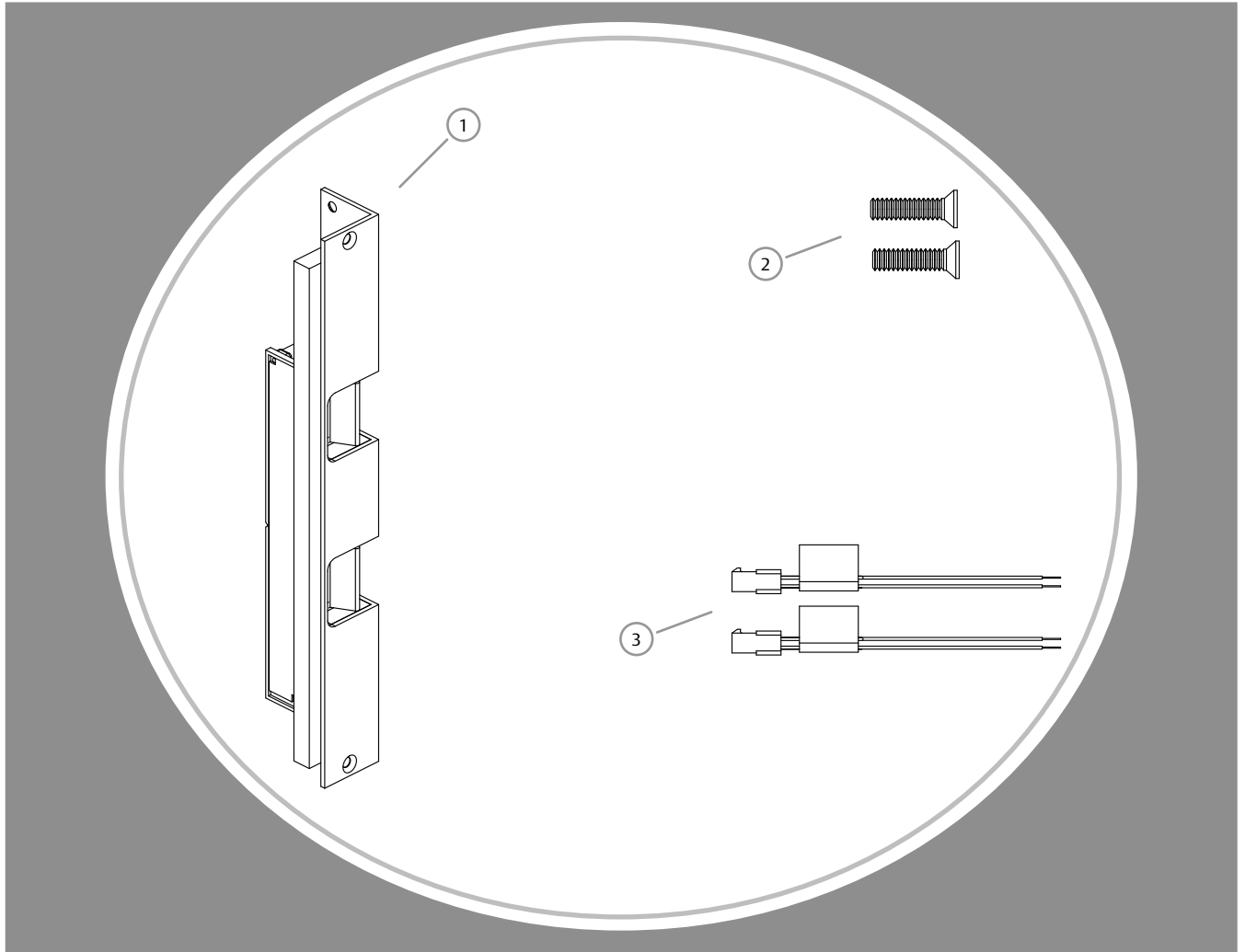

Electrical Specifications

ELECTRICAL RATINGS FOR SOLENOID*		
CONTINUOUS DUTY	12VDC	24VDC
Resistance in Ohms	23.5	96
Amps	.51	.25
Solenoids are rated at +/- 10% indicated value. *Resistance value indicated above is per coil.		

MINIMUM WIRE GAUGE REQUIREMENTS		
SOLENOID VOLTAGE	12VDC	24VDC
200 feet or less	18 gauge	18 gauge
200 - 300 feet	16 gauge	18 gauge
300 - 400 feet	14 gauge	16 gauge

Installation Directions

CAUTION! Before connecting any device at the installation site, verify input voltage using a multimeter. Many power supplies and low voltage transformers operate at higher levels than listed. Any input voltage exceeding 10% of the solenoid rating may cause severe damage to the unit and will void the warranty.

Prepare Strike

1. If using the LCBMA (Latchbolt monitor & Locking Cam Monitor), see Diagram 1 for wiring instructions.
2. The strike body ships as either a 12 or 24 volt unit and is not field selectable. Verify the available voltage is +/- 10% of the rated voltage of the strike body.

Prepare Frame

3. Prepare frame using the template for your strike located on pages 3-7.

Finish Installing

4. Connect the Plug In Connector to the electric strike, and connect wires from the Plug In Connector leads to the power source.
5. Install the electric strike unit in jamb cutout, using the #12-24 x 1/2" mounting screws.

Diagram 1: Monitoring Switches

Latchbolt Monitor (LBM)

White	Common
Orange	Normally Open
Green	Normally Closed

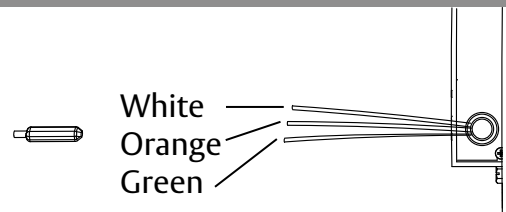

Locking Cam Monitor (LCM)

Brown	Common
Blue	Normally Open
Yellow	Normally Closed

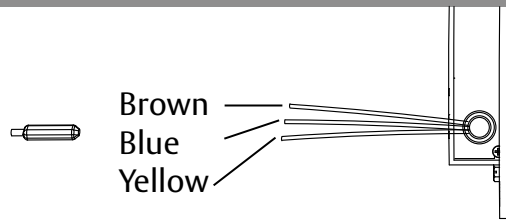

310-6-1 Template & Dimensions

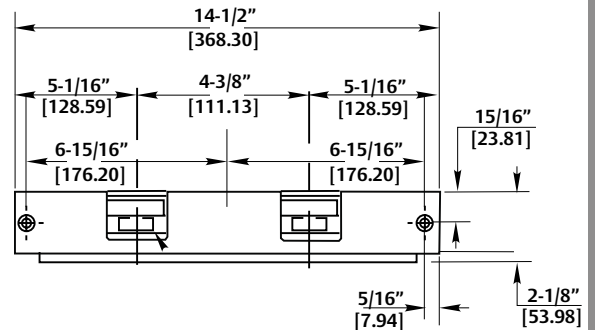
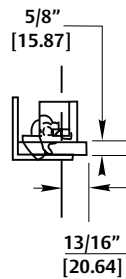
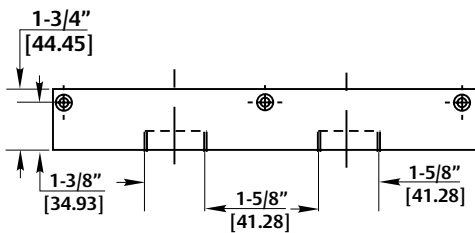
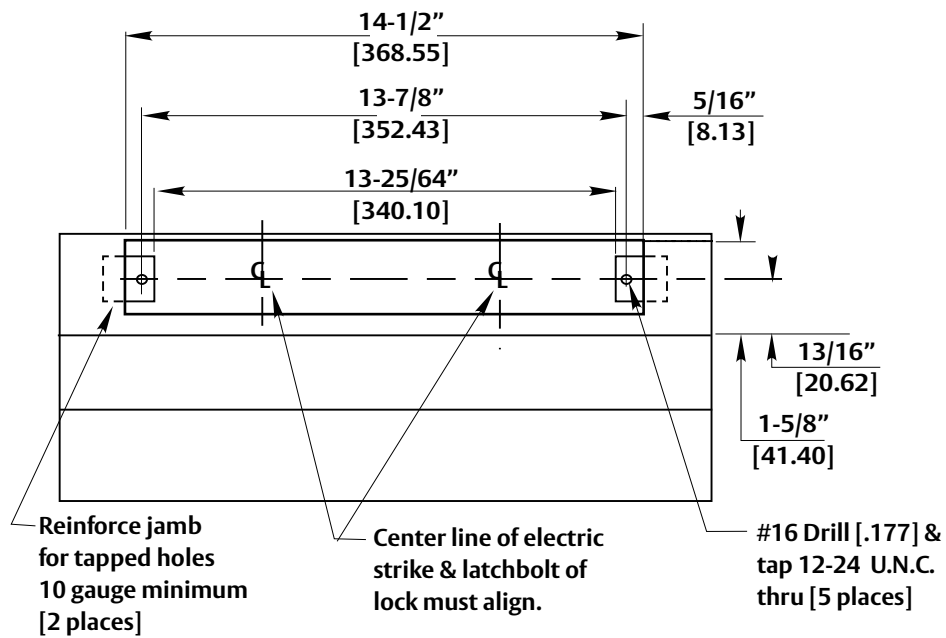
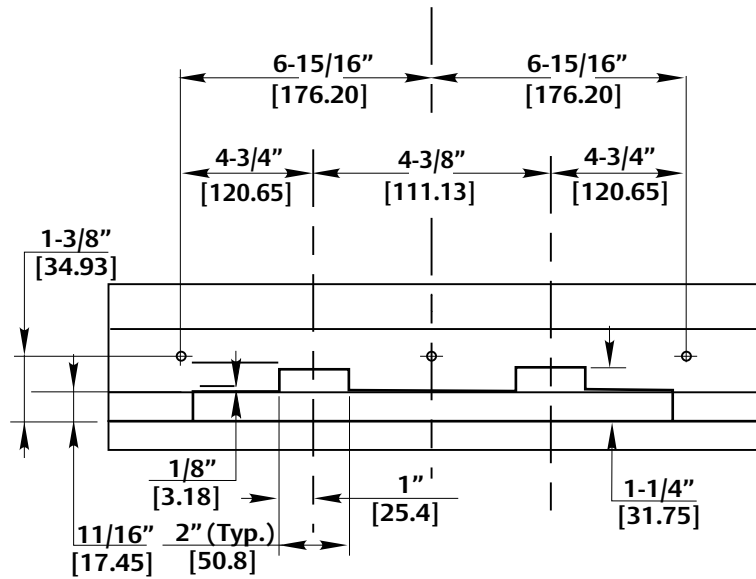

310-6-2 Template & Dimensions

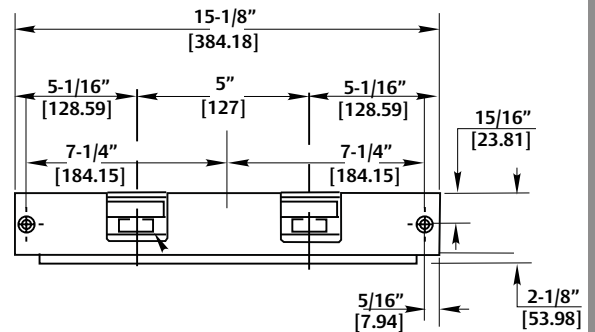
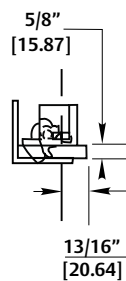
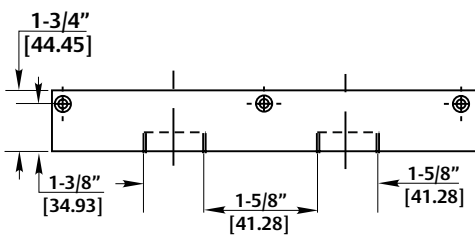
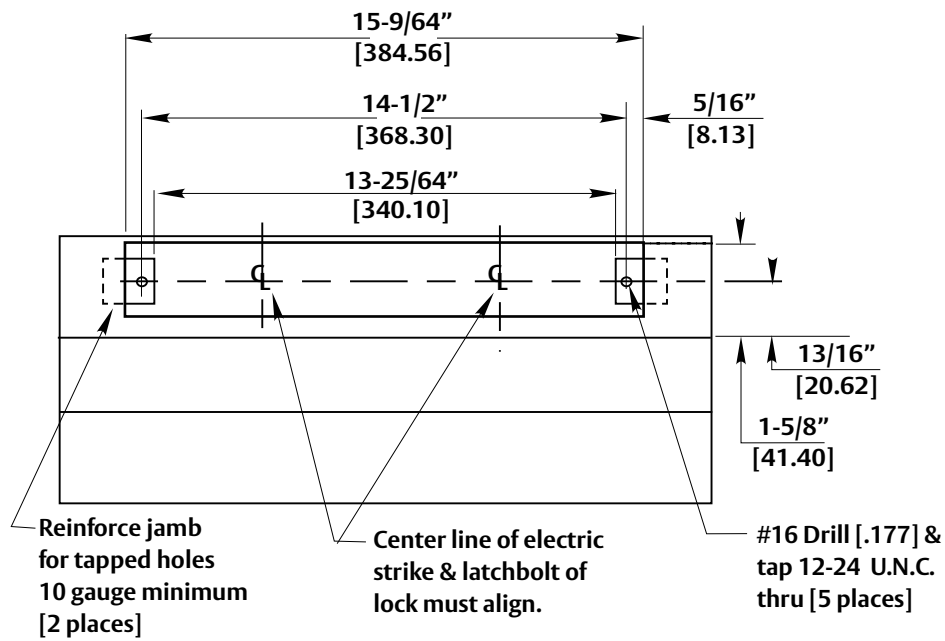
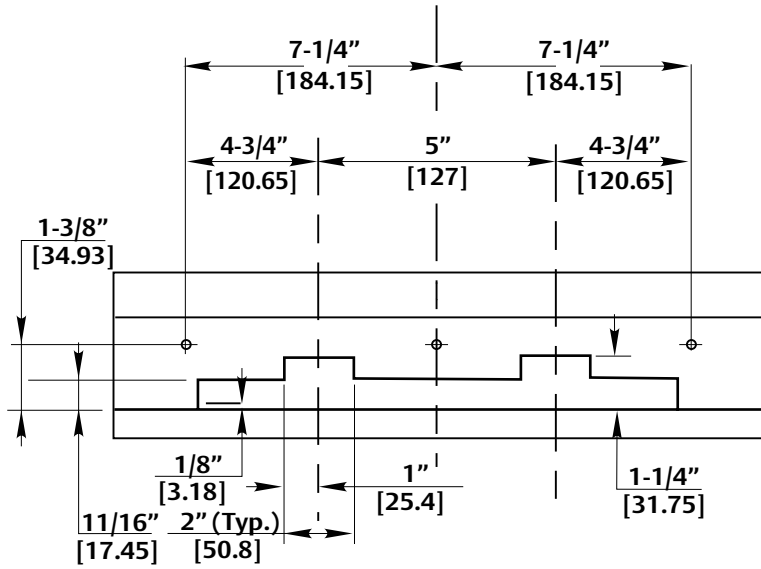

310-6-3 Template & Dimensions

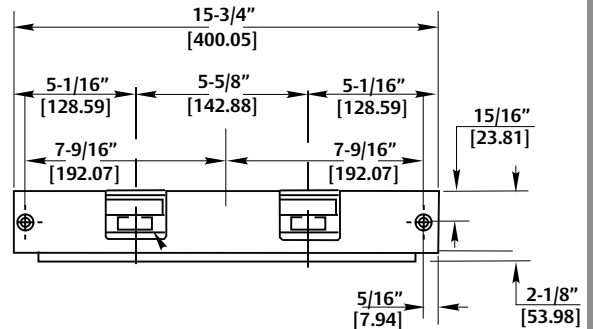
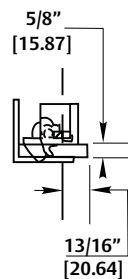
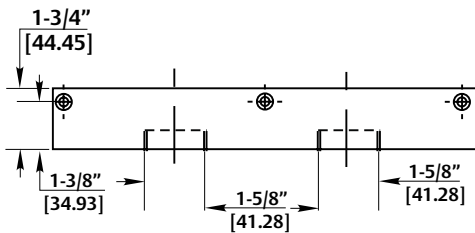
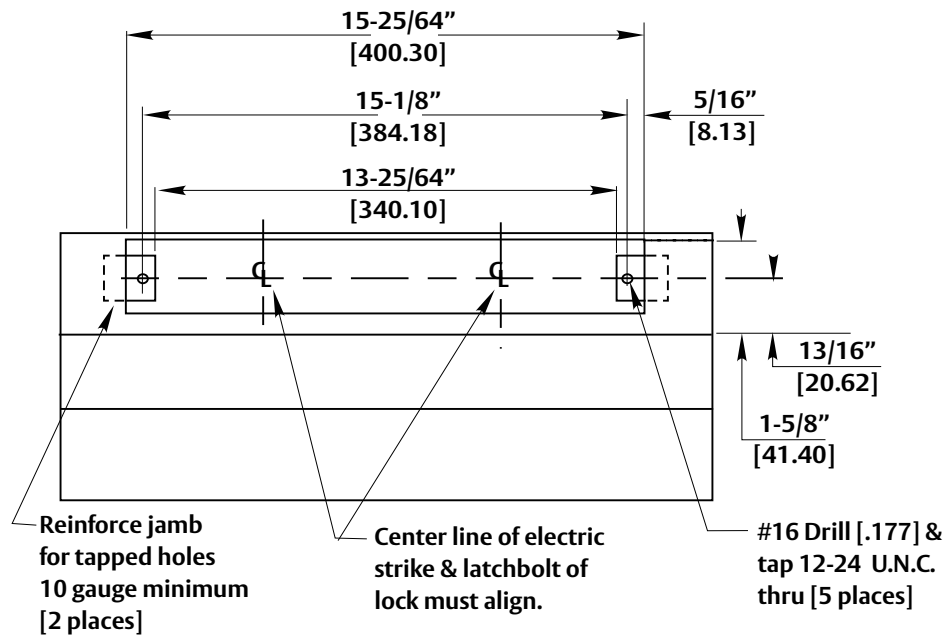
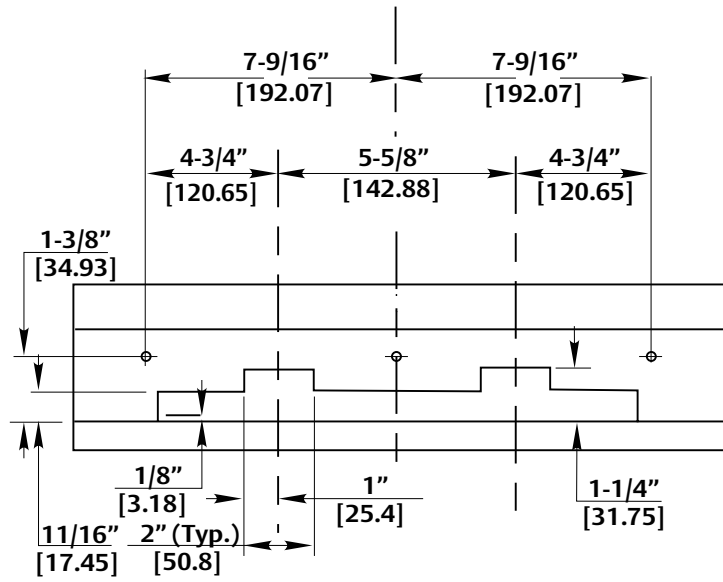

310-6-8 Template & Dimensions

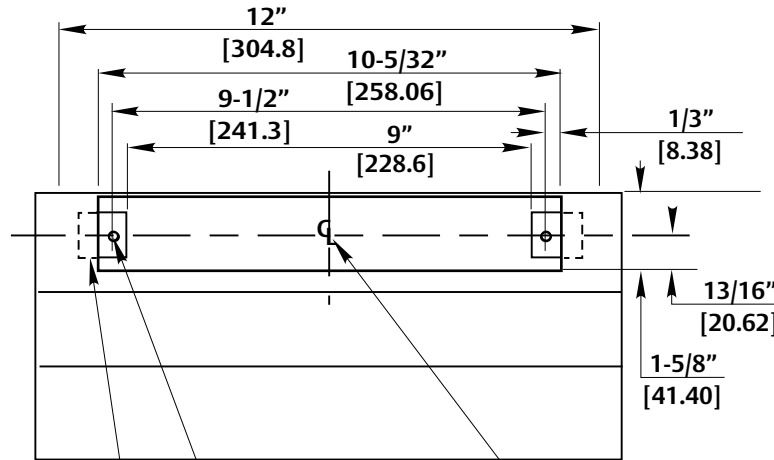
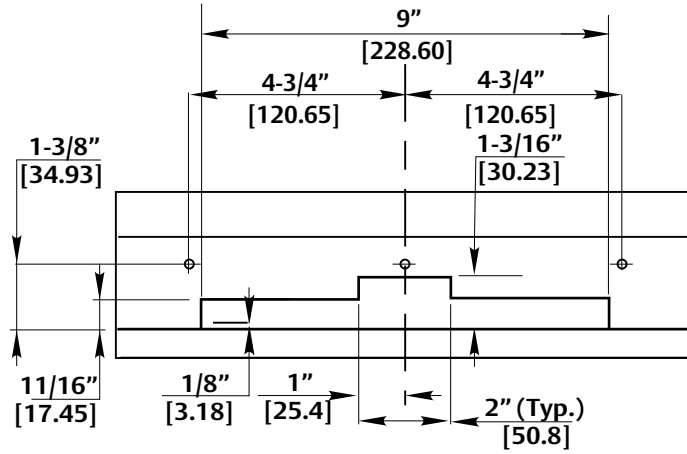

#16 Drill [.177] & tap 12-24 U.N.C. thru [5 places]

Center line of electric strike & latchbolt of lock must align.

Reinforce jamb for tapped holes 10 gauge minimum [2 places]

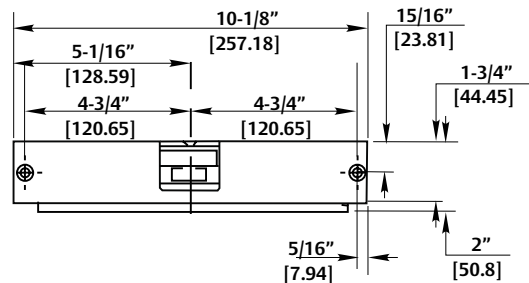
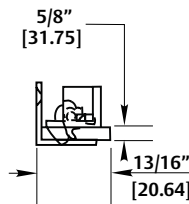
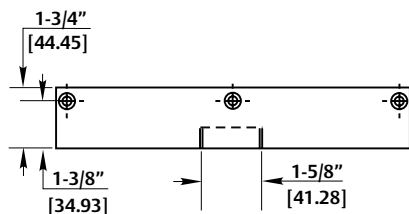

310-6-30 Template & Dimensions

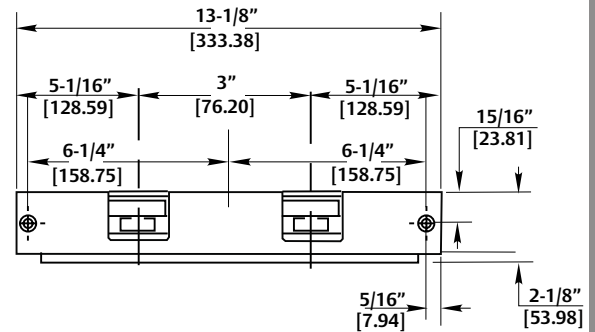
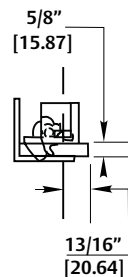
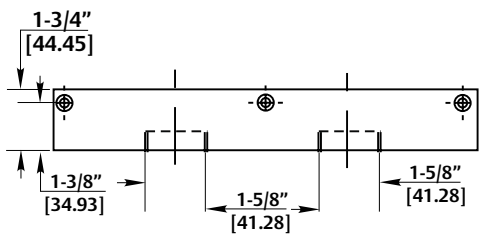
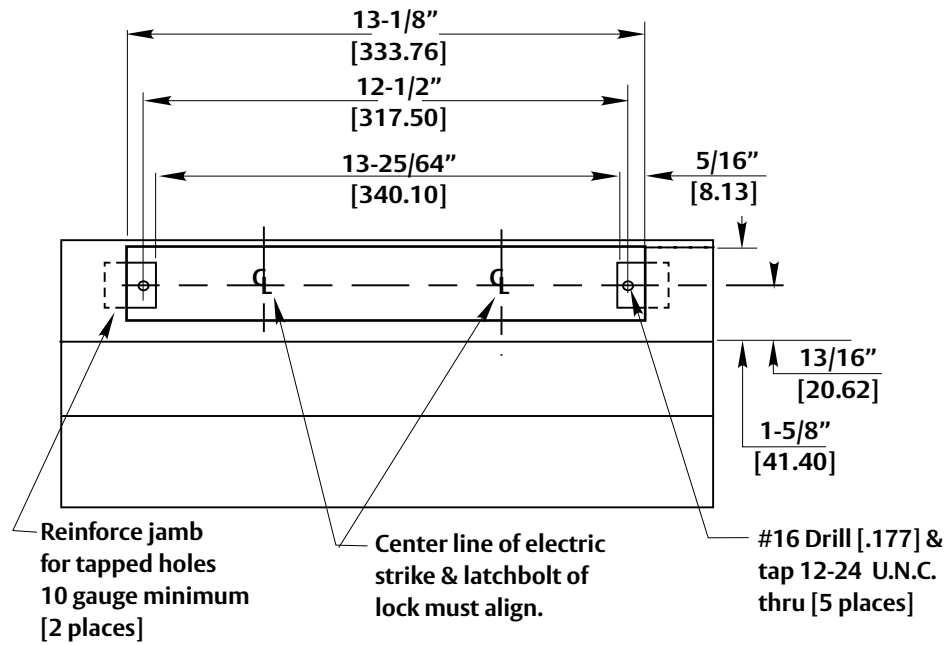
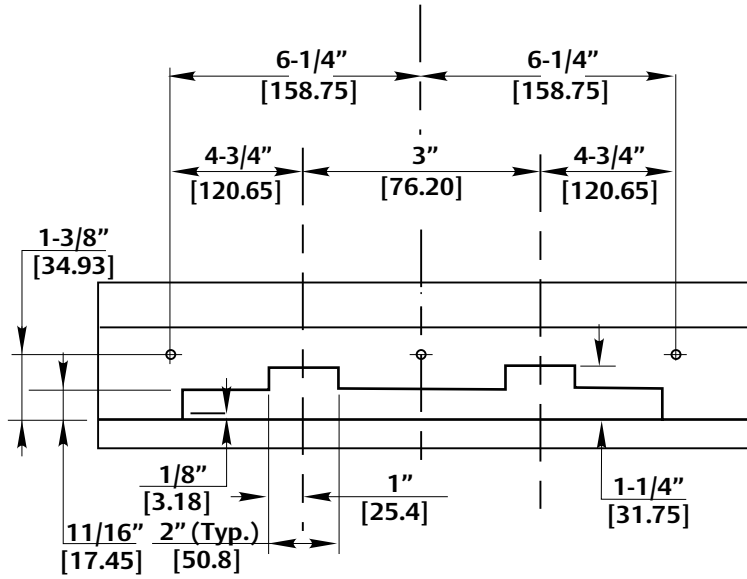

**This page intentionally
left blank.**